

Gemini TA3 Call for Access – 2018/19

The following information provides guidance for the Gemini TA3 experimental area for the 2017/18 proposal calls. It is recommended that you discuss your laser and experimental requirements with the appropriate CLF personnel prior to submission of your proposal.

Overview

To maximise scientific output, we would like to operate Gemini TA3 in **one** configuration during the whole period. This allows a common set-up to be arranged at the start to install and test the majority of the apparatus. Experiments with similar layouts will then be scheduled consecutively with a short break between to allow facility access for changeover.

Please contact Gemini staff to clarify any questions about your proposal. We request the applicants to use one of layouts described below. Any deviations from these layouts must be agreed with Gemini staff prior to submission.

Current Gemini specifications

Main Beams: North and South available

- a. Energy: ~13-14 J on South
 ~ 13-14J on North
 - b. Pulse length: 40-45 fs,
 - c. Beam diameter: 15 cm diameter
 - d. Focal spot $1/e^2$ radius: (using adaptive optics-
images on the right)
- F/20: 16.7 μ m
F/2: 1.6 μ m
- e. A close-in contrast scan is shown below.

The contrast parameters are:

- 10^{-10} ASE level (ns)
- 10^{-7} prepulse contrast (ps)
- 10^{-4} at 1ps

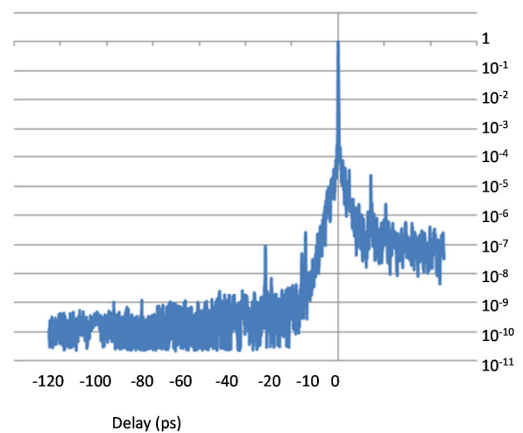
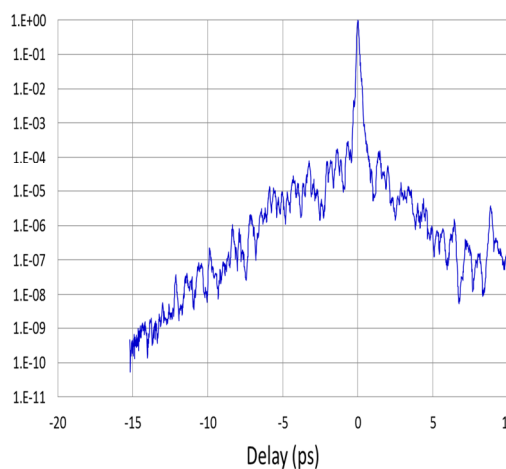
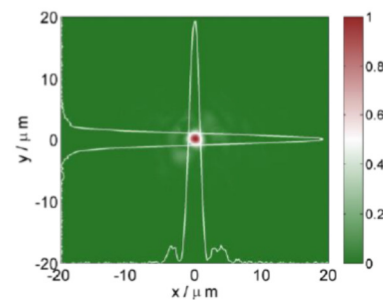
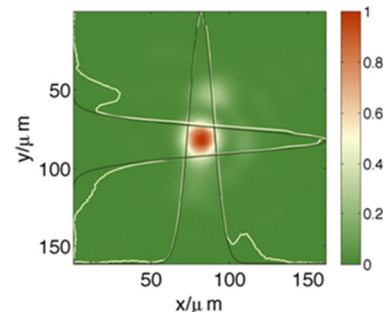

Permanent beam and alignment diagnostics available:

- a. A double plasma mirror system to improve the picosecond contrast to 10^{-6} at 1ps
- b. 10x, 20x and 50x magnification long working distance Mitutoyo objective lenses for focal spot imaging
- c. Adaptive optics on both beam lines
- d. Solid target positioning system (based on rear surface illumination)
- e. Back-scatter spectrum analysis for both beamlines
- f. Input Far field and near fields
- g. Overhead imaging of target chamber centre
- h. Single shot grenouille (model 8-10) for pulse length measurement after interaction
- i. All relevant laser parameters displayed on eCAT on a shot-to-shot basis.

Plasma diagnostics available:

- a. Thomson ion spectrometers
- b. Electron spectrometer (inside chamber/outside)
- c. Flat field spectrometer
- d. X-ray crystal spectrometers
- e. X-ray pinhole camera
- f. Optical spectrometers
- g. Solid target reflectivity monitors

Permanent target mounts/drives available:

- a. Wide variety of standard motorised and manual stages
- b. Custom built mounts on request (subject to budgetary constraints)
- c. Thick and thin film target wheel, x-y-z and rotary drives. Holding array targets.
- d. Standard gas jet and capillary mounts.

Mode of operation:

- a. The main optical layout will be built and tested in pre-setup weeks
- b. All diagnostics, cables etc. will be tested in pre-setup weeks
- c. Weekly system tuning: To ensure reliability of the system during the operations-heavy weeks, we may require up to 50% of a day (preferably Mondays) to tune up the system. All lost hours will be compensated by providing operational support during out-of-office hours.
- d. All non-standard diagnostics need to be discussed and agreed with the concerned CLF staff prior to proposal submission

Feasible Experimental Geometries

Proposed options for the configured access geometry are shown below.

Please contact Gemini staff if your proposal has requirements that are not covered by the options outlined here. For other focusing geometries please get in touch with Gemini staff as soon as possible.



(1) F/20 (South beam) with F/2 (North beam): 120 or 90 degrees between beams.

Diagnostic Location Options

F2 forward options:

- Single Thomson Ion Spectrometer (outside)
- Electron spectrometer (out or inside)
- Flat field x-ray spectrometer (outside)
- X-ray crystal spectrometer (out or inside)
- Pinhole camera (inside)

F2 35degree options:

- Triple Thomson Ion Spectrometer (30-45deg) (outside)
- Electron spectrometer (out or inside)
- Flat field x-ray spectrometer (outside)
- X-ray crystal spectrometer (out or inside)
- Pinhole camera (inside)

F20 forward options (inside):

- (*<60 deg range of angle supportable*)
- Thomson Ion Spectrometer
- Compact magnet electron spectrometer
- X-ray crystal spectrometer

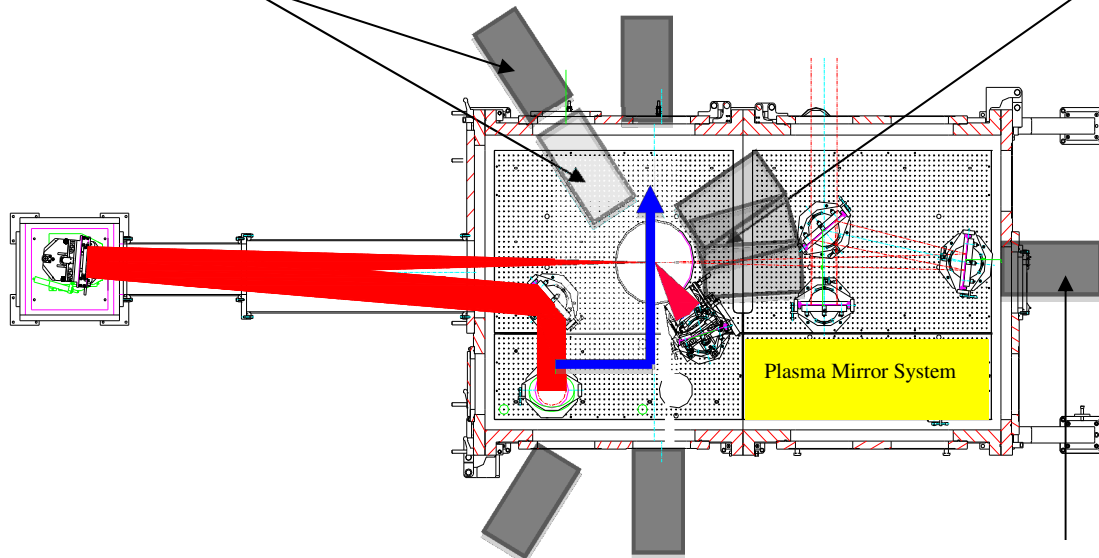

Reflected F2 options:

(*outside due to space and F20 beamline*)

- Thomson Ion Spectrometer
- Compact magnet electron spectrometer
- Flat-field spectrometer
- X-ray crystal spectrometer

Reflected F2 @ 35deg :

(*primarily outside due to F2 mount and probe*)

- Thomson Ion Spectrometer
- Compact magnet electron spectrometer
- Flat field x-ray spectrometer
- X-ray crystal spectrometer
- Pinhole camera

F20 forward options (outside):

- Thomson Ion Spectrometer
- Flat field Spectrometer (single or triple)
- Electron spectrometer
- X-ray crystal spectrometer
- Pinhole camera



Raised level beam transport is shown below to aid planning of out of plane diagnostics.

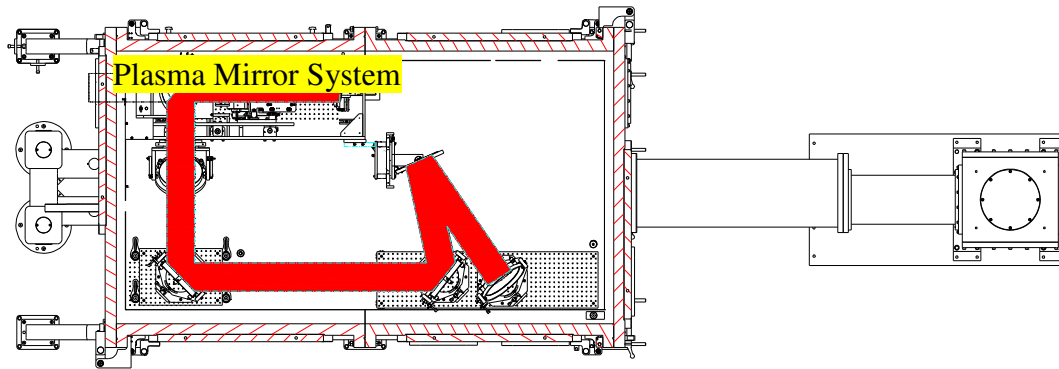

(2) F/2 (South beam) with F/2 (North beam): Small angle or 90 degrees between beams.

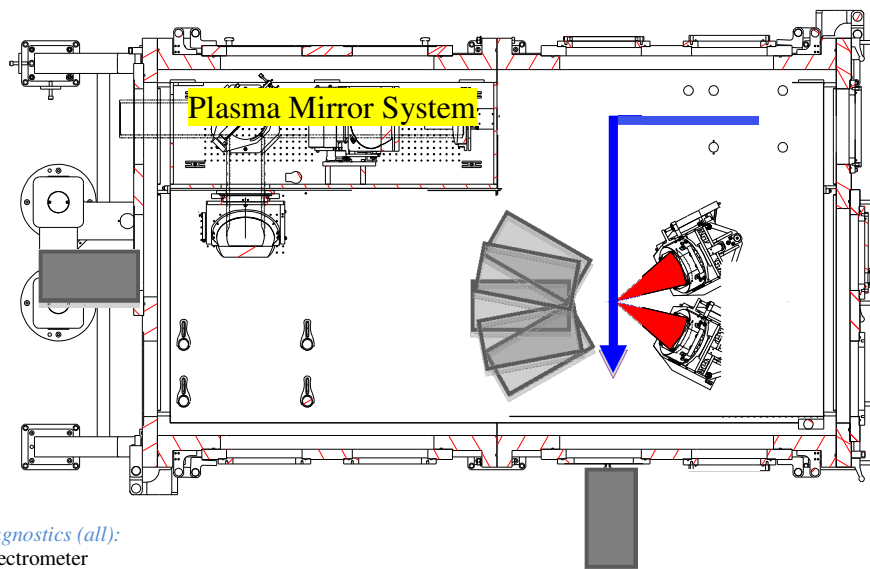

External port diagnostics (all):

- Thomson Ion Spectrometer
- Electron spectrometer
- Flat-field spectrometer
- X-ray crystal spectrometer
- Pinhole camera



Science & Technology Facilities Council
Rutherford Appleton Laboratory

Science & Technology Facilities Council
Rutherford Appleton Laboratory, Harwell Science and
Innovation Campus, Didcot, OX11 0QX United Kingdom

Tel +44 (0)1235 445000 Fax +44 (0)1235 445808
www.scitech.ac.uk

Raised level beam transport is shown below to aid planning of out of plane diagnostics.

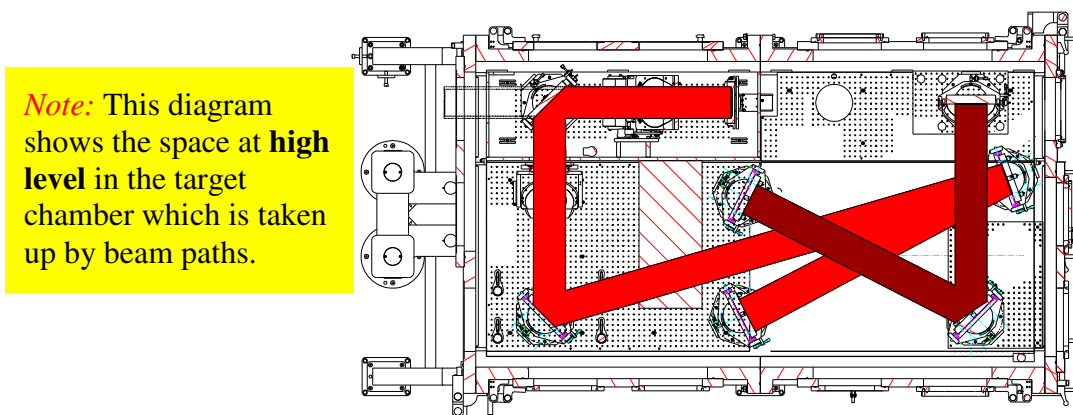

(3) F/20 (south beam) + F/20 (north beam)

Apart from these standard configurations, there **may** be an option of using F/20 + F/20 with 120 degrees between them or F/20 and F/2 (with a 20mm central hole) in co- or counter-propagating geometry. Applicants must contact Gemini staff if they are considering either of these options.

(4) F/40 (south beam)

In addition to this, we have tested an F/40 focusing geometry as the long-focus option in TA3. As it involves operating very close to the damage threshold of optics, please get in touch with Gemini staff if you are interested in using this geometry

