

48 Hour Operation of DiPOLE at 7 J and 10 Hz

Contact jonathan.phillips@stfc.ac.uk

P.J. Phillips, K. Ertel, P.D. Mason, S. Banerjee, J. M. Smith, T. J. Butcher, M. De Vido, W. Shaikh, O. Chekhlov, S. Tomlinson, A. Lintern, M. Fitton, R.J.S. Greenhalgh, C. Hernandez-Gomez and J.L. Collier

STFC Rutherford Appleton Laboratory, Central Laser Facility, Chilton, Didcot, OX11 0QX, UK

Introduction

Ultra-high intensity light-matter interactions enabling practical real-world applications for PW laser technology will demand development of lasers and support technology (targetry, diagnostics etc.), capable of operating under higher repetition rate conditions. These applications include laser particle acceleration, active online imaging and new medical therapies, which are reliant on efficient laser generation of ions (protons etc.) or secondary radiation (x-rays, γ -rays etc.) at pulse repetition rates of at least 10 Hz. The next generation of ultra-high intensity laser facilities, such as ELI-Beamlines [1,2] require PW class lasers capable of operating at high pulse repetition rates and high optical-to-optical efficiencies than current flash lamp pump technology will allow. Diode pumped solid state laser (DPSSL) technology overcomes the limitations of flash lamps and offers potential for efficient generation of high energy infrared pulses at 10s of Hz repetition rate. After frequency doubling these are suitable for pumping PW laser systems, based on Ti:sapphire or optical parametric chirped pulse amplifier (OPCPA) technology.

In previous publications we have presented a scalable concept for a diode pumped solid state laser (DPSSL) amplifier based on cryogenic gas cooled multi-slab Yb:YAG technology, capable of generating 1 kJ pulse energies [3,4]. Furthermore, we have published results of a scaled down prototype amplifier named DiPOLE demonstrating 10 J pulses at 10 Hz repetition rate [5, 6]. In this paper we describe the operation of DiPOLE over an extended period of 48 hours and also present results from frequency doubling experiments with LBO, DKDP (98%) and YCOB non-linear crystals.

Setup

The DiPOLE amplifier system consists of a fibre front end, regenerative amplifier, multi-pass amplifier and a cryogenically cooled power amplifier head. In the next couple of paragraphs we will briefly describe the various components.

Front end

The general schematic of the front end is shown in Figure 1. The front end consists of a narrow linewidth, wavelength tunable, cw fibre oscillator delivering approximately 15 mW at 1030 nm. This is then fed through a pair of phase modulators which can be used to broaden the spectral output. The phase modulators produce modulations in the frequency domain with two frequencies 2 and 14 GHz selectable. An acoustic optical modulator is then used to chop the cw output into a specified temporal output pulse width at a repetition rate of 10 kHz. The pulse is then amplified to 2W peak power in a multi-stage fibre amplifier. Finally, an electro optical modulator is used to precisely shape the pulse profile. The temporal shaping system has a 125 ps resolution and can produce pulse widths from 2 to 10 ns. The temporal pulse can then be manipulated to achieve the required pulse shape at the output of the amplifier chain.

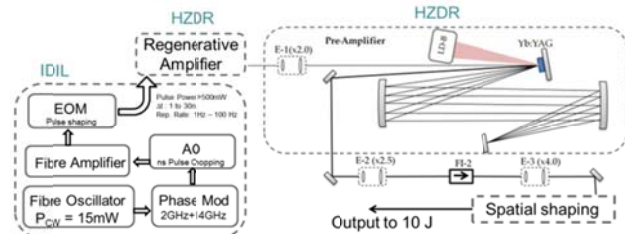

Figure 1: Schematic of the front end of DiPOLE.

The output of the fibre front end is used to seed a regenerative amplifier, which amplifies the temporally-shaped pulses to approximately 1 mJ energy at a reduced repetition rate of 10 Hz. The output of the regenerative amplifier is then propagated through to a booster multi-pass amplifier. This produces up to 100 mJ pulses with a near-Gaussian spatial profile. The output pulses are then spatially shaped by propagating through a square 20 mm x 20 mm serrated aperture and vacuum spatial filter (VSF). The efficiency of this passive shaping system is low reducing the available seed energy for the main power amplifier to around 30 mJ. Figure 2 shows the spatially-shaped beam used to seed the 10 J amplifier.

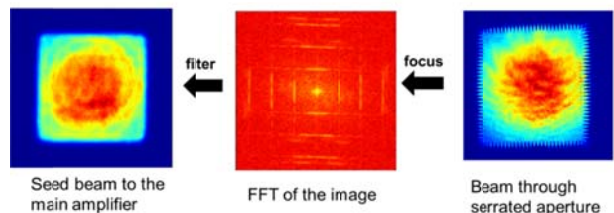

Figure 2: Spatial input beam into main amplifier after passing through the serrated aperture and spatial filter.

10 J amplifier

The DiPOLE amplifier head has four ceramic Yb:YAG gain discs, which have a co-sintered chromium-doped cladding for ASE suppression [5,6]. The discs are face cooled by a stream of cold helium gas at a nominal temperature of 150K. Cooling the Yb:YAG to these temperatures gives several significant advantages, including higher optical-to-optical efficiency, an increased gain cross section and better thermal-optical and thermal-mechanical properties. The central two gain discs have twice the doping level (2.0 at.%) of the outer two discs to equalise the heat load in the amplifier and reduce the overall thickness. The gain media are pumped from both sides by two laser diode systems, delivering a combined peak power of 40 kW and 40 J energy in 1 ms duration pulses at ~940 nm.

The spatially and temporally shaped seed beam from the front end is then injected into the main cryogenically-cooled amplifier, which uses angular multiplexing to allow six passes through the amplifier head. The amplified beam is repeatedly relay imaged back through the amplifier by a pair of 1:1 relay imaging telescopes. Figure 3 shows a schematic of the multi-pass system, where multiple telescopes on each side of the

amplifier share a single VSF tube each are containing pinholes on individually adjustable mounts.

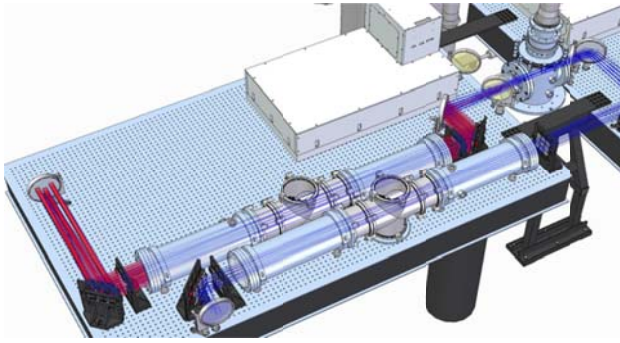

Figure 3: Schematic of image-relaying multi-pass geometry.

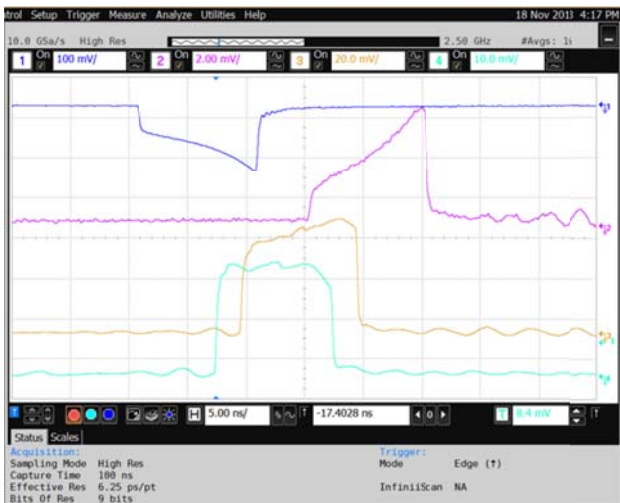

Figure 4: Evolution of temporal profiles through system leading to a super-Gaussian output temporal pulse. Blue: after fibre front end; purple: after regenerative amplifier; gold: after multipass amplifier; light-green: after main cryogenic amplifier.

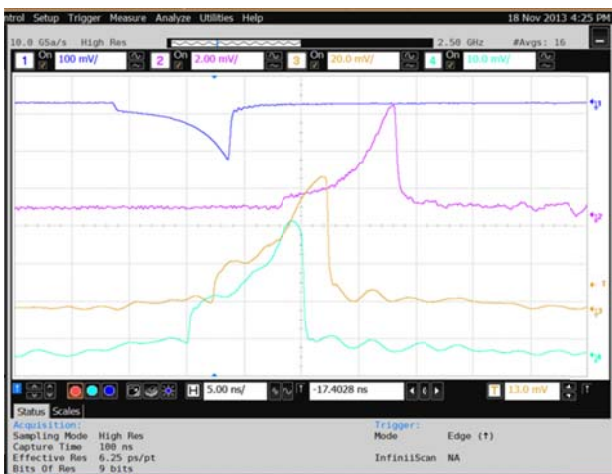

Figure 5: Temporal profiles with a rising edge, with various stages of evolution through the system. Colour coding is the same as for Figure 4.

To demonstrate the flexibility of our system to produce various different experiment-specific output temporal profiles, we generated a series of test pulse shapes. The first confirmed that a near-flat-top temporal pulse can be produced with pulse duration of 10 ns, as seen in Figure 4. The second demonstrates that a ramped output pulse with pulse duration of 10 ns can be produced, as seen in Figure 5.

We currently employ near and far-field cameras at the output, for diagnostics. We also have far-field diagnostics on the odd

passes 1, 3 and 5 for alignment and to monitor pointing stability. The temporal profile is monitored at every stage of amplification, namely at the output of the regenerative amplifier, the booster amplifier and, finally, at the output of the main 10 J amplifier.

10 J at 10 Hz results

We investigated the increase in output energy and efficiency with pump energy by changing the synchronisation of the pump with respect to the seed pulse. A fixed pump pulse duration of 1.2 ms was used and the effective pump energy was increased by increasing the delay between pump and seed. The cryogenic temperature for the Yb:YAG disks was set at 137 K for these experiments. Figure 6 shows the increase in output energy with effective pump energy as seed delay is increased. A maximum output of 10 J was measured at 10 Hz repetition rate for a 10 ns duration seed pulse, corresponding to an optical-to-optical efficiency of 21%.

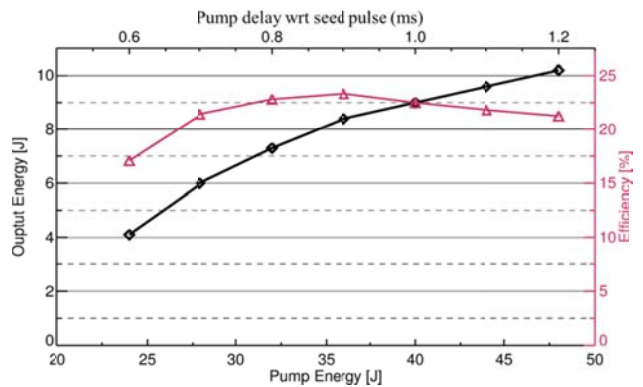

Figure 6: Dependence of output energy and efficiency on pump energy for the DiPOLE amplifier.

48-hour operation at 7 J and 10 Hz

After demonstrating 10 J at 10 Hz we then set up the DiPOLE amplifier to mimic the design fluence for the 100 J system, currently being built for the HiLASE project in the Czech Republic [7]. The new 100 J system, named DiPOLE100, is designed to operate at a peak fluence of 2 J/cm² to reduce the possibility of damage to the amplifying gain medium and other optics in the system. For DiPOLE this fluence corresponds to maximum output energy of 7 J. Under these conditions the DiPOLE amplifier was run for 48 hours in 4 to 6 hour stretches, to simulate typical operating conditions that would be encountered at the HiLASE facility for experiments. The measured output from DiPOLE over the 48 hour period is shown in Figure 7. The combined runs demonstrated an energy stability of 0.85% rms for over 1.8 million shots. Moreover, in one particular run an energy stability of 0.07% rms was observed over 1000 shots, as shown in Figure 8.

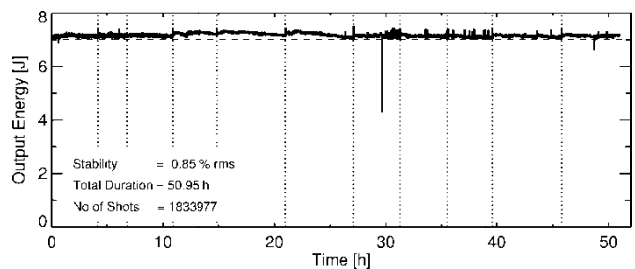

Figure 7: Plot of output energy during 48 hour operation of the DiPOLE amplifier.

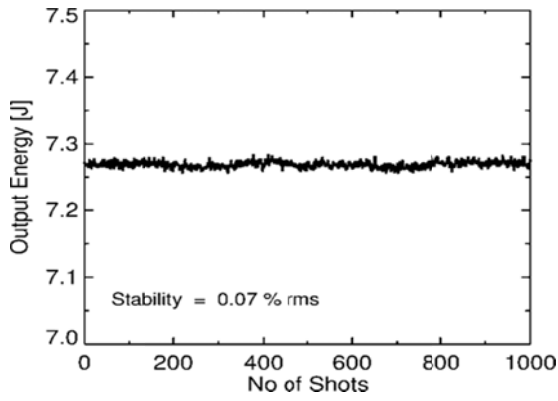

Figure 8: Energy stability of DiPOLE amplifier at an output greater than 7 J for 1000 shots.

Frequency doubling

In order to test the suitability of the 10 J output, and subsequent designs of the DiPOLE system, for use as a pump for OPCPA and Ti:Sapphire amplifiers we carried out a series of frequency doubling experiments. Three non-linear crystals were selected for testing the efficiency of frequency doubling the 1030 nm output from the DiPOLE amplifier into the green at 515 nm, with the aim to identify the crystal capable of delivering maximum efficiency. To determine the optimum crystal length we used the SNLO program [8] for second harmonic generation (SHG). All the frequency doubling crystals chosen employed Type I phase matching. The results of calculations for operation at the DiPOLE output fluence are shown in Figure 9. The optimum crystal lengths are approximately 30 mm for YCOB and LBO, and 75 mm for DKDP (98%). For the experimental tests we purchased a 13 mm length LBO and a 15 mm length YCOB crystals and a 50 mm length DKDP crystal, due to time and cost constraints. The dimensions of the crystals purchased were as follows:

- LBO: 30 mm diameter x 13 mm long
- DKDP: 80 mm x 80 mm aperture x 50 mm long
- YCOB: 30 mm x 30 mm aperture x 15 mm long

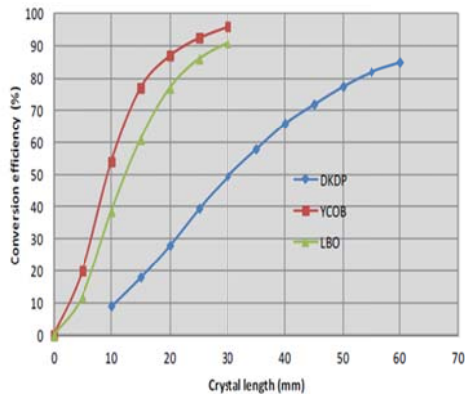

Figure 9: Calculation performed by SNLO to calculate the length of crystal required for DiPOLE.

These crystals have been identified as possessing suitably low absorption for operating at high repetition rates. The tolerance of phase matching of these crystals to misalignment with respect to the input beam is small, as shown in Table 1.

	DKDP	LBO	YCOB
Angular acceptance (mrad.cm)	2.5	9	1.6

Table 1: Angular acceptance for type I phase matching

The frequency doubling experiment in DiPOLE was setup as shown in Figure 10.

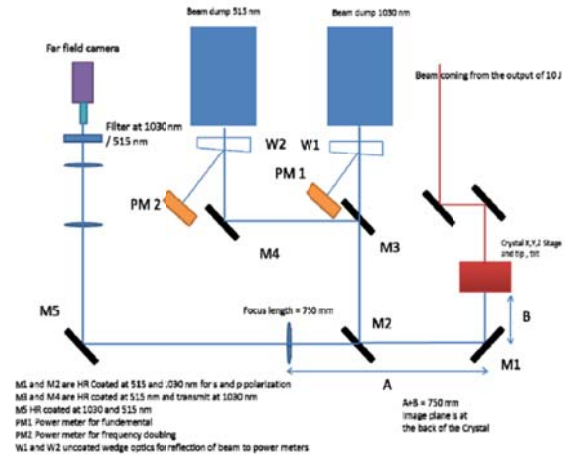

Figure 10: Schematic diagram of the frequency doubling experiments.

The output of the DiPOLE amplifier was directed through the frequency doubling crystal via two high reflectivity mirrors, which provided near field position and pointing adjustment. The unconverted fundamental and frequency doubled radiation was reflected from high reflectivity mirrors M1 and M2 into the power measurement diagnostic section. Leakage through M2 was fed via M5 to a camera, which recorded the image relayed far field distribution of the frequency doubled beam at the output of the crystal. The input to the camera was filtered to remove the fundamental radiation. After reflection at M2, the frequency doubled component of the output beam was separated from the fundamental by dichroic mirrors M3 and M4, and the beams directed into the beam dumps as shown.

The output polarisation of the DiPOLE amplifier was measured and found to have an elliptical polarisation with ~80% of the fundamental in the “o” polarisation state. The output of the amplifier was then set to 7 J. The beams were sampled using the front surface reflection from uncoated windows (W1 and W2) and directed into the calibrated power meters (PM1 and PM2).

Material	Z-Direction Outer temp (K)	Z-direction Inner temp (K)	Differential (K)	Temp acceptance (K.cm)	Temp acceptance (K.)length ⁻¹
DKDP (Convection)	35.2	39.1	3.9	11.3	2.6
DKDP (forced)	30	32.9	2.9	11.3	2.6
YCOB (Convection)	42.3	42.9	0.6	105	70
YCOB (forced)	30.0	30.37	0.35	105	70
LBO (Convection)	42.1	43.3	2.2	5	3.3
LBO (forced)	30	30.7	0.7	5	3.3

Table 2: The results of thermal modelling with the temperature difference between the inner and outer parts of the crystal.

Prior to the experiments, crystal temperature maps were calculated for a 7 J beam with both forced and natural convection. These were used to determine differential temperatures and predict the effect of heating on conversion efficiency. A synopsis of calculated values is found in Table 2 and this only refers to the temperature map in the Z-direction which is the travel.

The calculations show that maximum conversion efficiency should be achievable for LBO and YCOB as the differential temperature is inside the corresponding temperature acceptance bandwidth as calculated by SNLO. Whereas, the greater absorption present in DKDP at 1030 nm leads to temperature rises outside the calculated acceptance bandwidth for this crystal. Therefore the frequency doubling efficiency for this crystal is expected to be lower than that predicted by SNLO.

Experimental results

The maximum conversion efficiency obtained from LBO was 65% at 10 Hz, which was lower than predicted from SNLO, as shown in Figure 11. As the graph of efficiency versus fundamental energy has not reached saturation it should be possible to increase efficiency further by increasing input energy. The discrepancy between measured and calculated efficiency values can be explained by two factors. Firstly, as indicated previously, only 80% of the fundamental light is in the correct polarisation state for frequency doubling and, secondly, the measured wavefront of the fundamental showed a distortion of $0.8 \lambda_{rms}$ over the beam. At maximum output the frequency conversion experiment was run for a period of over 8000 shots (> 10 minutes) and during this time there was no degradation in the conversion and no damage to the crystal or associated optics.

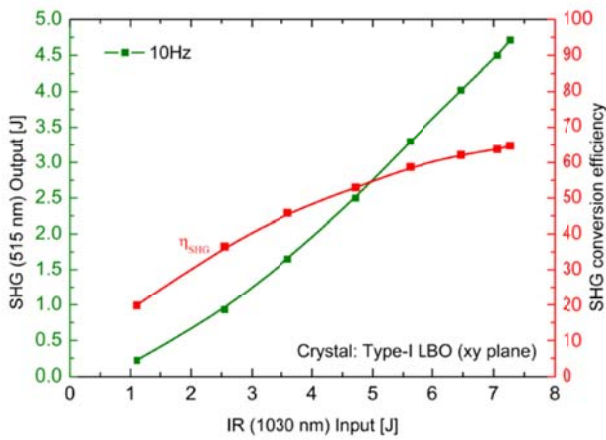

Figure 11: Frequency doubling conversion for LBO with a maximum efficiency of 65%.

The DKDP crystal was tested in the same set up at 10 Hz and the efficiency was also found to be lower than predicted by SNLO, although this was to be expected as the temperature calculations predicted a reduction in efficiency. The maximum efficiency was measured to be 45%, as shown in Figure 12. The detrimental effect of crystal heating can easily be seen in the experimental results measured at 1 Hz, where the reduced thermal load led to an improved conversion efficiency of 58%. This value was still lower than predicted due to the same reasons given for LBO.

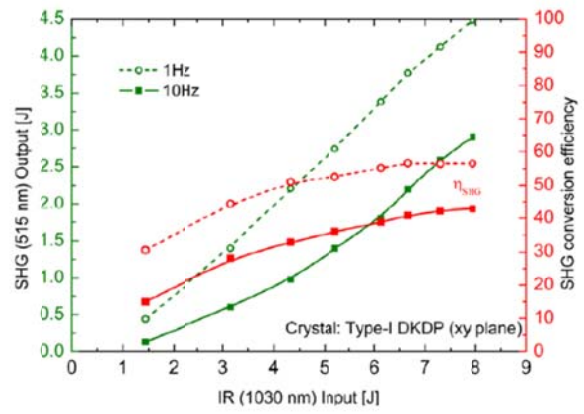

Figure 12: Frequency doubling conversion for DKDP crystal with a maximum efficiency of 45% at 10 Hz. Efficiency rose to 58% at 1 Hz.

The maximum conversion efficiency measured for YCOB was 50%, as shown in Figure 13, which is significantly below the calculated value of 78%. We attribute this to the same issues as explained for LBO, but also the crystal may have been of lower optical quality than specified. We also tested this crystal for a period of 8000 shots within which time there was no degradation of conversion efficiency or damage to the crystal. Furthermore, the lower angular acceptance is also a possible contributing factor as to why the efficiency is reduced, as YCOB has a value 2 times less than DKDP and 5 times less than LBO.

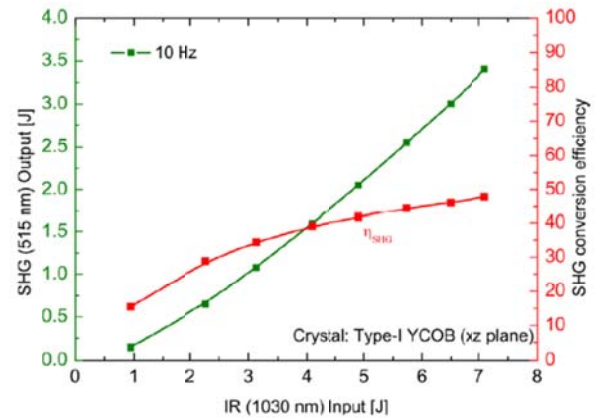

Figure 13: Frequency doubling conversion for YCOB with a maximum efficiency of 50%.

At present LBO crystals are not available with apertures large enough to frequency double the output beam (75 mm square) of DiPOLE100 directly. This is due to current growth issues with LBO, although research into growing larger crystals is ongoing, and there is the possibility, in the near future, of 80 mm square aperture crystals becoming available. For currently available crystals the output beam would have to be reduced in size to 50 mm to be able to use an LBO crystal with 60 mm square aperture. The effect of this is to increase the fluence on the crystal. In order to confirm that this is acceptable, we tested our current LBO crystal at an increased fundamental fluence by reducing the DiPOLE output beam size from 18 mm square to 10 mm square, by installing a beam reducing telescope. We then ran DiPOLE at an output energy of 6 J, corresponding to a fluence on the crystal of 6 J/cm^2 . The results of these experiments can be seen in Figure 14. Operation at higher input fluence increased our efficiency from 65%, Figure 11, to 72% as seen in Figure 14. At these higher fluences there was no observable damage to the LBO crystal for operation at 10 Hz over 10 minutes.

Furthermore, we carried out an additional experiment to confirm that conversion efficiency could be increased by optimising the input polarisation. To do this we introduced a quarter and half wave-plate at the output of the amplifier before the crystal to achieve linearly polarised output. We measured the polarisation at the output at low energy and after adjustment of the wave-plates achieved 98% polarisation in the 'o'-plane. Under these conditions, the frequency doubling efficiency increased from 72% to 78%. A graph depicting this is also shown in Figure 14. These results confirm that LBO is currently the best choice of non-linear crystal for frequency doubling the output from DiPOLE. All these experiments were carried out with no active cooling for any of the crystals tested.

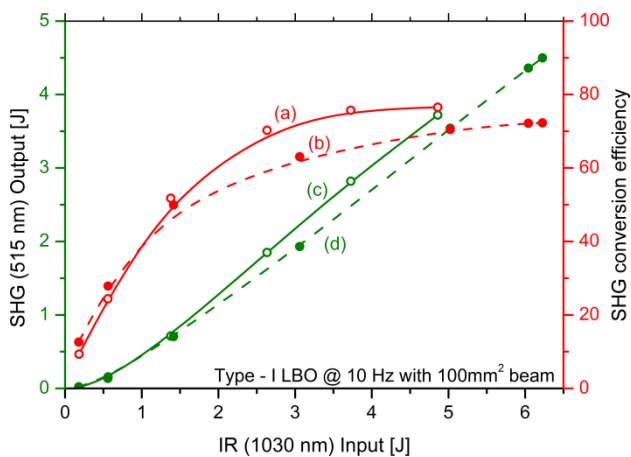

Figure 14: Comparison of SHG conversion (green) and efficiency (red) versus input energy for LBO crystal with (solid (a, c)) and without (dashed (b, d)) polarisation correction.

Current plans

The current plan for DiPOLE is to continue to use it as a test bed for optical designs, new components and coatings that will be used on DiPOLE100. We plan to test gain media polished by different techniques with a view to improving their damage resilience, and to install an AO mirror to improve the output wave front quality. This should further enhance the frequency doubling efficiency. Furthermore, we are currently testing an active beam stabilisation system on the DiPOLE front end in order to improve long-term pointing stability. Beam steering will be used extensively on DiPOLE100.

Conclusions

DiPOLE has achieved its design specification of 10 J pulse energy at 10 Hz repetition rate in a 10 ns duration pulse. DiPOLE has been successfully operated for 48 hours at output energy of 7 J with an energy stability of 0.85% rms.

DiPOLE has also been used to generate 4.7 J of 515 nm radiation at 10 Hz from 7.0 J input energy, with a maximum conversion efficiency of nearly 80% achieved using a LBO crystal.

Acknowledgements

We would like to acknowledge the funding of EUROLITE for continued cooperation with other European laboratories. We also like to thank Cristal Laser for the loan of the LBO crystal.

References

1. Extreme Light Infrastructure (ELI) Beamlines Facility, Prague, Czech Republic www.eli-beams.eu.
2. The HiPER project, <http://www.hiper-laser.org>.
3. K. Ertel, S. Banerjee, P. D. Mason, P. J. Phillips, M. Siebold, C. Hernandez-Gomez, J. L. Collier "Optimising the efficiency of pulsed diode pumped Yb:YAG laser amplifiers for ns pulse generation." Opt. Express, 19, 26610-26626 (2011).

4. P. D. Mason, K. Ertel, S. Banerjee, P. J. Phillips, C. Hernandez-Gomez, J. L. Collier, "Optimised Design for a 1 kJ Diode Pumped Solid State Laser System", Proc. SPIE 8080, 80801X (2011).
5. S. Banerjee, K. Ertel, P. D. Mason, P. J. Phillips, M. Siebold, C. Hernandez-Gomez, J. L. Collier "High efficiency 10 J Diode pumped Cryogenic Gas Cooled Yb:YAG Multi-Slab Amplifier" Opt. Letters, 2715, Vol 12 (2012).
6. P. D. Mason, K. Ertel, S. Banerjee, P. J. Phillips, C. Hernandez-Gomez, J. L. Collier, "Multi-slab Yb:YAG cryogenic gas cooled high average power amplifier delivering 7.4 J at 10 Hz" CLF Annual report 2012-2012.
7. HiLASE <http://www.hilase.cz/en/>.
8. SNLO program, <http://www.as-photonics.com/snlo>.