

## A high average power OPCPA system for the Attosecond Basic Technology Project

P. Bates, Y. Tang, E. Springate and I. N. Ross

Central Laser Facility, STFC, Rutherford Appleton Laboratory,  
Harwell Science & Innovation Campus,  
Didcot, Oxon., OX11 0QX, UK

G. H. C. New, R. A. Smith, J. W. G. Tisch and  
J. P. Marangos

Blackett Laboratory, Imperial College,  
Prince Consort Road, London SW7 2BZ, UK

Main contact email address

[e.l.springate@rl.ac.uk](mailto:e.l.springate@rl.ac.uk)

### Introduction

We have developed an Optical Parametric Chirped Pulse Amplification (OPCPA)<sup>[1,2]</sup> laser system to act as a drive laser to produce attosecond XUV pulses through high harmonic generation<sup>[3]</sup>. The laser system is part of the Attosecond Basic Technology program and the attosecond XUV pulses produced with this laser will be used in a wide variety of molecular physics and surface science experiments. The laser will produce 10 mJ, carrier-envelope phase-stabilised few-cycle pulses at 1 kHz. It includes a novel transmission grating based stretcher-compressor system, designed to compensate spectral phase across a 400 nm bandwidth. The optical parametric amplifiers (OPAs) are pumped by a high peak and average power diode-pumped Nd:YLF laser, which will produce 85 mJ, 40 ps, 523.5 nm pulses at 1 kHz. The layout of the system is shown in figure 1. Initial tests of amplification have shown gain across the full 330 nm bandwidth of our seed pulses.

In OPCPA, the amplifier in a standard chirped pulse amplification system is replaced by a non-linear crystal which provides gain via optical parametric amplification. OPAs have extremely large gain bandwidths that can allow amplification of the full bandwidth of a 5 fs pulse<sup>[1,4]</sup>. Minimal thermal deposition in the OPA medium allows for high average power operation and high optical quality due to the absence of thermal lensing. This enables orders of magnitude higher pulse energies than are available from conventional few-cycle systems and the amplification of few-cycle pulses up to the terawatt level through OPCPA has recently been demonstrated<sup>[5,6]</sup>.

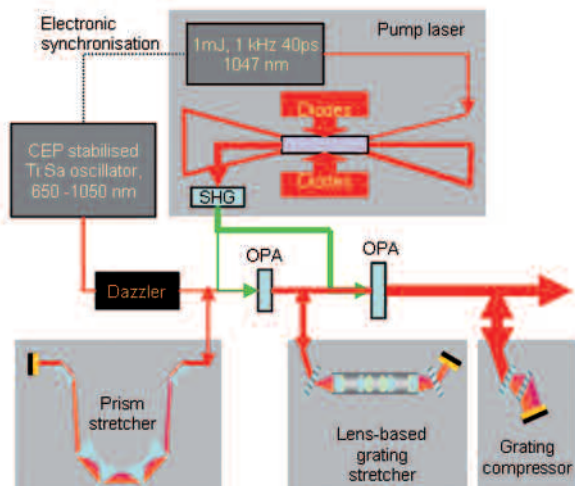

Figure 1. Schematic of the OPCPA system.

### High average power pump laser

High average power OPCPA requires a high average and peak power pump laser and efficient conversion of pump to signal. We have built a diode-pumped Nd:YLF amplifier which will produce pulse energies up to ~200 mJ at 1047 nm with pulse durations of ~40 ps and repetition rates up to 1 kHz.

The pump laser design is based on Nd:YLF, as it has a high energy storage efficiency, and efficiently absorbs pump light at diode laser wavelengths. It also has a low non-linear index, exhibits low thermal lensing and is naturally birefringent, reducing the impact of stress-induced birefringence. While Nd:YLF is in many respects an ideal laser material for this application, its major disadvantage is the low thermal fracture limit at a thermal load of ~18 Wcm<sup>-1</sup>. We are collaborating with MPQ to investigate the fracture limits resulting from different manufacturing methods.

The front end of the pump laser consists of a commercial oscillator-regen unit, providing 1 mJ, 40 ps pulses at 1047 nm. The output of this is then amplified in a diode-pumped Nd:YLF amplifier. The amplifier is pumped by five laser diode bars providing a total of 5 kW peak pump power (1.25 kW average power) to pump a 100 × 5 mm deep-etched Nd:YLF rod at 15 Wcm<sup>-1</sup>. The amplifier head is shown in figure 2.

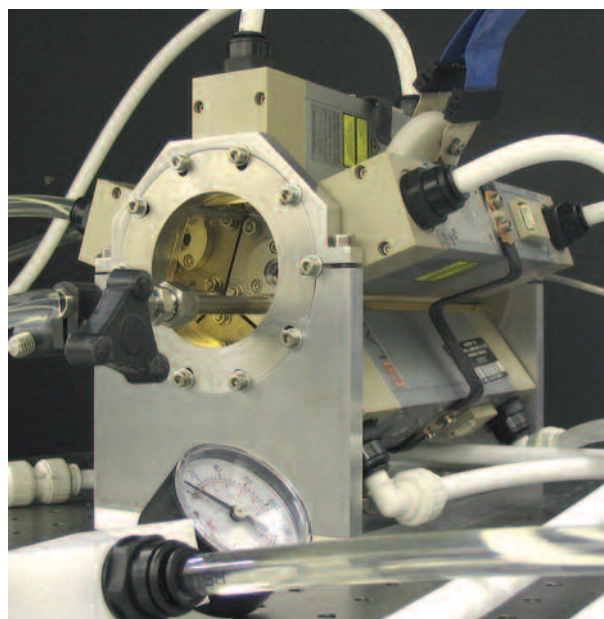
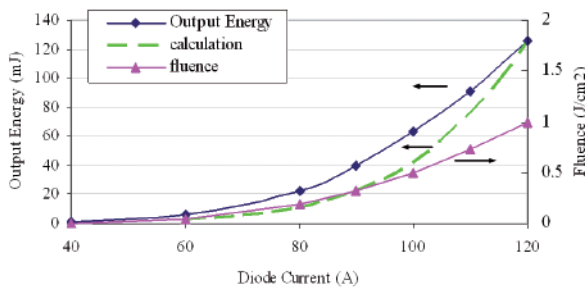

Figure 2 Nd:YLF amplifier head, showing the five 1 kW diode bars mounted around the rod.

The operation of the amplifier has been analysed in detail to enable the maximum pulse energy to be achieved without exceeding the limits set by self-focusing and thermal fracture<sup>[7]</sup>. The low thermal fracture limit means that it is important to pump the rod as uniformly as possible. We use long arrays of vertically-stacked bars, which match the length of the Nd:YLF rods, to achieve homogeneous pumping along the length of the rod. The 40° fast axis divergence of the diode beams ensures that the rod is filled along the optical axis, while the 10° slow axis divergence is corrected by long cylindrical lenses to match the cross-section of the rod. The glass tube, which contains the coolant for the laser rod is partially aluminium coated on the outside to reflect transmitted light back into the rod. The expected overall coupling and absorption efficiency in the rod is ~70%.

At a 10 Hz repetition rate, we obtain pulse energies up to 130 mJ (fig 3) with good beam quality. The amplified pump pulse is then frequency doubled with a conversion efficiency of >50% and image relayed onto the OPA crystals. The Nd:YLF oscillator is electronically synchronised to the Ti:Sapphire seed oscillator, reducing the pump-seed timing jitter in the OPA stages to less than 1 ps.

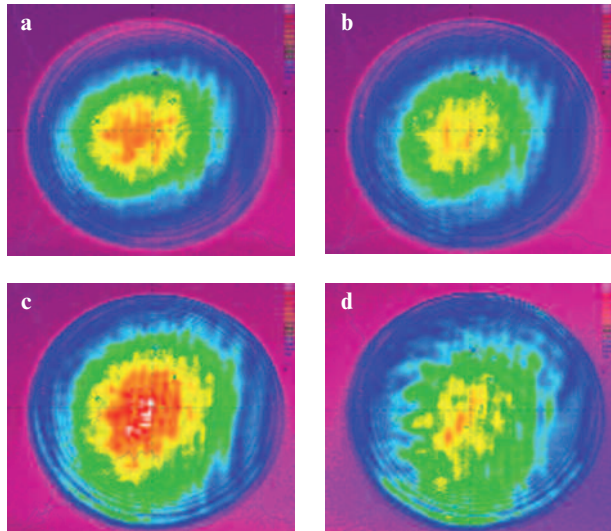

**Figure 3. Measured and calculated output energy and fluence at 10 Hz.**

We are now working to increase both the energy and repetition rate of this system. Initial tests increasing the repetition rate up to 200 Hz have shown a drop in output energy corresponding to a drop in absorption in the rod of ~10%. Thermal lensing becomes significant above ~100 Hz, as can be seen from the beam profiles in figure 4. We are designing a system of lenses to compensate for this.

### Seed source

In order to exploit the extremely large gain bandwidth available in OPCPA systems we require a light source capable of producing coherent radiation across an immense bandwidth. In our initial configuration we used a commercial 12 fs oscillator to produce the seed pulses, which were then broadened in an optical fibre. The high intensity oscillator pulses were coupled into an extremely small diameter photonic crystal fibre core, where the high intensity and long interaction length produces a number of non-linear effects including self-phase modulation (SPM), soliton production, four wave mixing and cross phase modulation. The main spectral broadening effect is due to SPM, which acts on the leading and trailing edges of the pulse temporal profile to create new wavelengths at either end of the spectrum. Initial results from this system were promising, with the production of bandwidths spanning over 500 nm (figure 5). However the output spectrum from these fibres exhibited large amplitude and spectral



**Figure 4. Beam profiles from the Nd:YLF amplifier at repetition rates of (a) 10 Hz, (b) 50 Hz, (c) 100 Hz and (d) 200 Hz.**

fluctuations, spectral variation across the spectral profile, non-single mode output profiles as well as deep modulation of the spectrum over the original pulse bandwidth. Attempting to compress the output of the fibre we saw direct evidence of multiple pulse production in the fibre.

Due to the unreliability of the fibre output we deemed it an unsuitable choice for an OPCPA seed system and chose to upgrade our oscillator to a 6 fs system (Femtolasers Rainbow) with bandwidth spanning from 640-1030 nm at the 5% points. This system provides coherent seed radiation at all wavelengths of the OPA gain spectrum.

### Stretcher-Compressor development

As an OPCPA system directly amplifies pulses with very large bandwidths, this requires stretcher and compressor designs that can handle these bandwidths. We have developed a stretcher-compressor system capable of stretching an 850 nm pulse with 200 nm FWHM (~400 nm edge-to-edge) bandwidth to 20 ps and recompressing to 5 fs<sup>[8]</sup>. The basis of the design is to use gratings as the principal means for stretching and compressing since these can in principle exactly compensate for each other for spectral phase over all orders. However there are

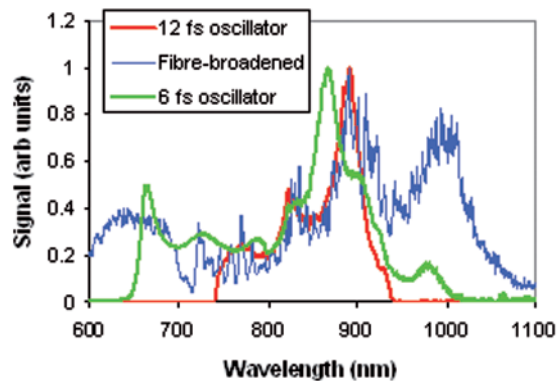

**Figure 5. Seed spectrum directly from 12 fs oscillator (red) and after broadening in 2 mm photonic crystal fibre (blue). The final system will use the seed from the 6 fs oscillator (green).**

necessarily bulk media in the system and the grating devices are not able to sufficiently compensate for the higher order phase terms introduced by these. To balance the system, we have found it necessary to include a prism stretcher which controls the higher order terms at short wavelengths. The gratings can then be adjusted to compensate for the higher order terms at longer wavelengths and a programmable acousto-optic phase filter (Dazzler) removes any fine residual phase errors.

The grating stretcher and compressor use transmission gratings as these can have high efficiency and damage threshold and a larger bandwidth than reflection gratings. An additional advantage is the ability to use them at the Littrow angle with small separations. We have measured double-pass transmission of over 50% in both stretcher and compressor, which are shown in figure 6. Our stretcher incorporates a custom-made 8-element lens system to provide -1 magnification across the full bandwidth while maintaining the collimation of the input beam. Ray-tracing calculations show a minimal change (< 3 fs across the full edge-to-edge bandwidth) in group delay across our 2 mm beam. The lens contains a substantial amount of high-index glass, but the rest of the stretcher system has been designed to compensate for the higher order terms this introduces.

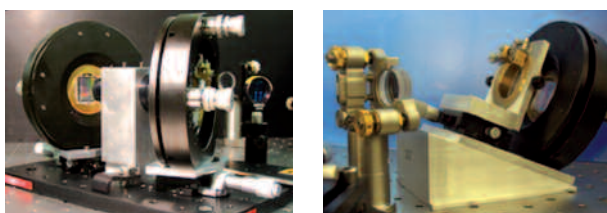

**Figure 6.** The compact transmission-grating based stretcher (a) and compressor (b). The compressor gratings are just 6 mm apart and mounted on a wedge to give a large out-of-plane angle which helps balance higher order phase terms.

During initial tests of the system with 12 fs seed pulses, we successfully stretched these 200 nm bandwidth pulses to 9 ps with the grating stretcher and prisms, and then compressed down to 14.2 fs with the grating compressor (figure 7). For optimisation of the compression, we use a SPIDER to measure the spectral phase of the pulses.

Carrier-envelope phase (CEP) stabilisation permits precisely defined optical electric fields to be produced<sup>[3]</sup>. This is particularly important for the generation of isolated attosecond pulses, which requires that there is only one strong maximum in the electric field of the drive laser pulse. We have incorporated carrier-envelope stability considerations onto our design. The oscillator contains in-built CEP stabilisation, through active feedback control of the effective cavity length. The stretcher and compressor have been designed to minimise variations in the CEP with beam-pointing variation. Any slow drifts in CEP at the output of the system will be measured and actively controlled with a second, commercial, CEP stabilisation unit.

### Optical parametric chirped pulse amplification

The OPA stages consist of two LBO crystals used in non-collinear geometry. They have been modelled using a 2-D code which includes beam walk-off and diffraction effects and is enabling us to investigate transverse effects across the beam profile.

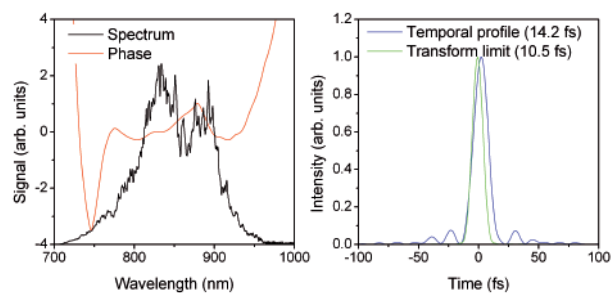

**Figure 7.** (a) Spectral phase measured with SPIDER (red) and amplitude (black) of pulses stretched to 9 ps and recompressed. (b) Retrieved pulse with 14.2 fs FWHM (blue line) and the 10.5 fs FWHM transform limited pulse (green line).

Our multi-component stretcher-compressor scheme enables us to access pulses of different lengths at various points through the stretcher. For the first OPA stage, we amplify a 1 ps duration seed pulse in a 7 mm long crystal. The high intensity of this short pulse enables us to easily achieve saturation while the 40:1 ratio of pump-seed duration allows temporal multiplexing and greatly reduces the effect of timing jitter of the pump. Initial tests of the first stage show a gain of  $\sim 10^5$  over a 330 nm bandwidth (fig 8), corresponding to a 7.6 fs transform-limited pulse. By choosing to saturate heavily in the OPA stages, it is possible to increase the amplitude of the various spectral components to provide an optimum spectral profile after amplification.

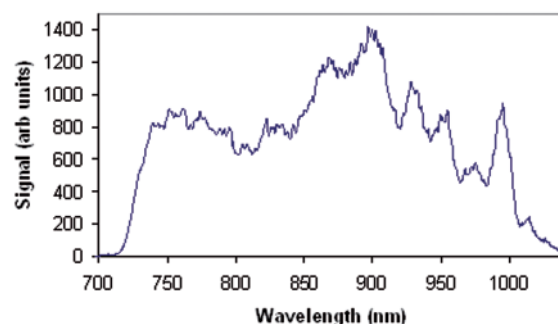

**Figure 8.** Measured amplified signal spectrum after the first double-passed OPA stage. The 7 mm long LBO crystal was pumped at  $1 \text{ J cm}^{-2}$  and the output signal energy was 25  $\mu\text{J}$ .

The 3.5 mm long second stage will be seeded with the first stage output, stretched to 20 ps duration. This 2:1 pump-seed ratio will maximise the amplification efficiency. Our calculations show that we can amplify the full spectrum of a few-cycle pulse with 23% extraction efficiency. With pump pulse energies of 85 mJ, the predicted final signal energies after compression are in the region of 10 mJ.

The complete system will be on the cutting edge of current sub-10 fs laser technology and will provide a valuable experimental tool for use in the Attosecond Basic Technology programme at Imperial College London.

The authors would like to acknowledge EU funding support for this project via the OTTER JRA.

## References

1. I. N. Ross, P. Matousek, M. Towrie, A. J. Langley and J. L. Collier, *Opt. Commun.* **144**, 125 (1997).
2. A. Dubietis, G. Jonusauskas and A. Piskarskas, *Opt. Commun.* **88**, 437 (1992).
3. A. Baltuska *et al.*, *Nature*, **421**, 611 (2003).
4. T. Kobayashi and A. Baltuska, *Meas. Sci. Technol.* **13**, 1671 (2002).
5. S. Witte, R. Th. Zinkstok, A. L. Wolf, W. Hogervorst, W. Ubachs and K. S. E. Eikema, *Opt. Express*, **14**, 8168 (2006).
6. F. Tavella, A. Marcinkevičius and F. Krausz, *Opt. Express*, **14**, 12822 (2006).
7. Y. Tang, M. Divall, I. N. Ross, E. Springate and G. J. Hirst, "High-power Nd:YLF Amplifier Development", CLF Annual Report 2004 - 2005, p248.
8. P. Bates, E. Springate, Y. Tang and I. N. Ross, "Design of a Stretcher-Compressor System for High Energy 5 fs Pulses", CLF Annual Report 2004 - 2005, p251.